

SBB(S) -5930Series – R002

Low Ohmic EB Welded SMD Precision Resistor

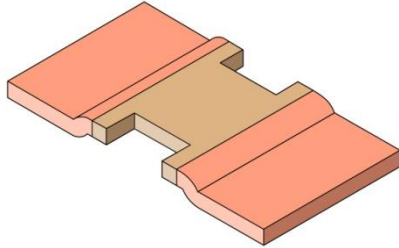

Features

- High Conductivity Copper Connectors
- Excellent Long Term Stability
- High Application Temperature Range -55°C to +170°C
- Max. Solder Temperature up to 350°C / 30Sec
- Flame Resistant
- Solid Metal Construction
- RoHS and REACH Certified
- AEC-Q200 Qualified

Applications

- Current Sensing/ Feedback
- Automotive Applications
- Power Modules
- Frequency Convertors
- Inverters
- Low Inductance Applications



Technical Data		
Resistance Value	2	(mΩ)
Tolerance	1, 5	(%)
TCR - Temperature Coefficient (Resistive Alloy)	< -25 (Aluchrom Alloy)	(ppm/K)
Applicable Temperature Range	-55 to +170	°C
Load Capacity (P _{100°C})	5	W
Inductance	<3	nH
Stability Deviation	< 0.5 after 2000 Hours, T _i * = 110°C	%
	< 1.0 after 2000 Hours, T _i * = 140°C	%
* T _i = Terminal Temperature		

Table 1

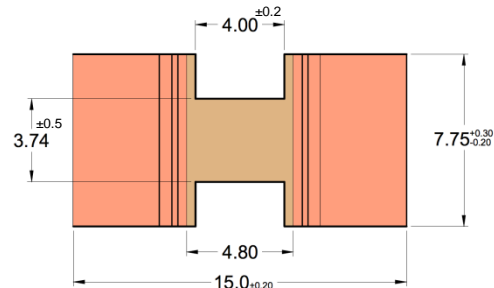
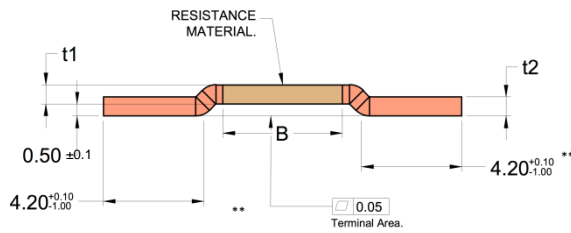

Type	Resistance Value (mΩ)	Material	t1 +/- 0.10 (mm)	t1 +/- 0.10 (mm)	TCR (ppm)	P _{70°C} (W)	P _{100°C} (W)	B (mm)
SBB (S) -AC-R002	2.0	Aluchrom Alloy	0.91	0.91	< 50	9	5	5.0

Table 2

All dimensions are in mm, See table 2 for thickness.



SBB(S) - 5930 Series – R002

Low Ohmic EB Welded SMD Precision Resistor

Power Derating Curve

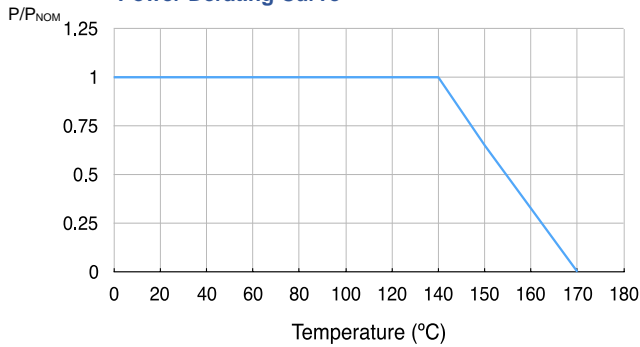

Resistance Change vs Temperature

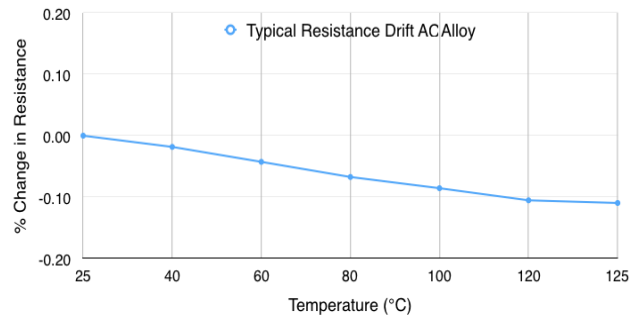

Performance:

Type of Test	Reference STD	Test Specifications	Acceptance Criteria
High Temperature Exposure	MIL-STD-202 Method 108	1000Hrs. @ T=170°C.Unpowered.	ΔR +/-1%
Temperature Cycling	JESD22 Method JA-104	-55°C to 150°C, 1000Cycles, 30Mins at each extreme	ΔR +/-0.5%
Biased Humidity	MIL-STD-202 Method 103	85°C & 85RH with 10% operating power, 1000Hrs	ΔR +/-0.5%
Operational Life	MIL-STD-202 Method 108	125°C at rated power,1000Hrs	ΔR +/-1%
External Visual	MIL-STD-883 Method 2009	Visual inspection	Visual
Physical Dimension	JESD22 Method JB-100	Dimensional inspection as per SBCL Specifications	Shall confirm within tolerance limits
Resistance to Solvents	MIL-STD-202 Method 215	Clean with Aqueous chemical	Marking shall be legible
Mechanical Shock	MIL-STD-202 Method 213	100g for 6ms, Half sine	ΔR +/-0.2%
Vibration	MIL-STD-202 Method 204	5g for 20Mins, 12 cycles each of 3 orientations.10-2000Hz	ΔR +/-0.2%
Resistance to Soldering Heat	MIL-STD-202 Method 210	Solder Temp. 260°C, Time 10Secs	ΔR +/-0.5%
Solderability	J-STD-002	As per J-STD-002	>95% Coverage in 10x Magnification
Electrical Characterization	User Spec.	Resistance as defined	Shall confirm within tolerance limits
Short Time Over Load	--	5x Rated Power for 5Secs	ΔR +/-1%
Low Temperature Storage	--	-65°C for 24Hrs	ΔR +/-0.2%

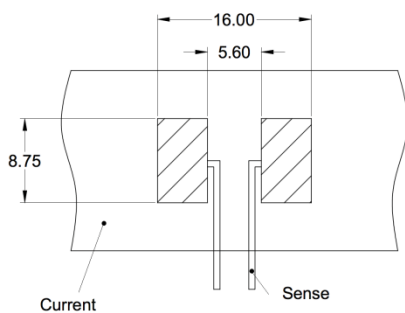

PCB Layout (Solder Pads) (mm)



SBB(S) - 5930 Series – R002

Low Ohmic EB Welded SMD Precision Resistor

Reel Information	
Reference Standard	DIN EN 60286-3
Width of Reel	24 mm
Number of parts per Reel	2000 pcs

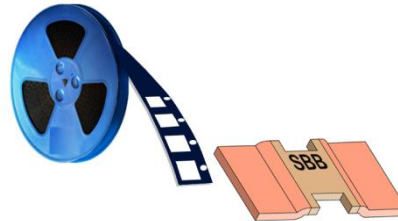

Ordering Code

